

How-to-Kit Active Literacy

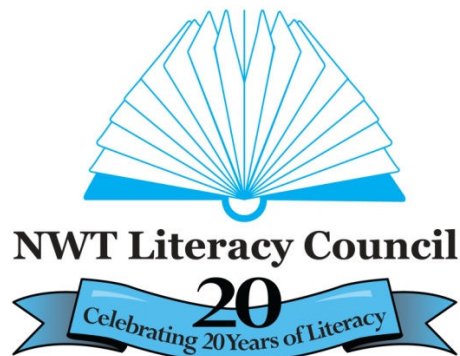



Celebrate Literacy in the NWT

Other How to Kits & Literacy Activities

Active Literacy was created to help celebrate the NWT Literacy Council's 20th anniversary. It is part of a series of How to Kits, all of which are available for download at www.nwt.literacy.ca Feel free to print, photocopy and use any of these kits at home or in your program.

- 1-2-3 Rhyme with Me
- Community Book Swap
- Family Reading Party
- Games Night
- Literacy Treasure Hunt
- Pyjamas and Book Party
- Reading Circles and Story Extenders
- Scattergories
- Storytime on the Radio
- Family Literacy Activities Night
- Book Making
- Literacy Games for Adults
- Get Caught Reading & Other Promotion Ideas
- Election
- Environmental Print Games
- More Literacy Games
- Read for 15
- Writing and Publishing Children's Books
- Science Fun
- Involving Families in Children's Learning
- Literacy Activities for Holidays – Thanksgiving, Halloween, Christmas, Valentine's Day, Easter, Birthdays
- Puppet Making
- Writing Contest
- Culture and Traditions
- Books in the Home
- Facilitating a Workshop
- Talking Books
- Family Math
- Family Cooking
- Readers Theatre
- Family Literacy Activities Night 2
- Word & Picture Bingos
- Plan a Family Literacy Fair
- Storysacks
- Literacy Survivor
- TV Free from A to Z

You are welcome to download and use these kits.

NWT Literacy Council

Box 761

Yellowknife, NT X1A 2N6

Phone: 867-873-9262 Fax: 867-873-2176

Toll Free in the NWT: 1-866-599-6758

Email: nwtliteracy@nwtliteracy.ca

Website: www.nwt.literacy.ca

Literacy Games

People of all ages can play literacy games. They can be a lot of fun. They can help make the learning environment more comfortable and interesting. Play them in any language – English, French, or an Aboriginal language!





Community Scavenger Hunt

Holding a scavenger hunt is a great way to have lots of fun with your friends, family and neighbours.

1. Prepare a list of items that each team must find or use the list on the next page.
2. Give each team the list of items that they must find.
3. Give each team a bag to hold their collected items.
4. As a group, decide and set the rules. For example,
 - Teams must ask the owner's permission before borrowing something.
 - Teams must return anything that they've borrowed.
 - Teams must be back by _____. (decide the time)
5. You may wish to add different items to the list. You might include that teams must get the signature of a particular person in town... the mayor, the chief, a teacher. (Be sure to have their permission first!)
6. The first team to come back with all of the items wins.
7. You may wish to assign point values to each of the items. Items that are more difficult to find get a higher point value. The team with the highest number of points would be the winner.
8. Finish the day with a barbeque and award the prizes!



Community Scavenger Hunt

With your team try to collect everything listed below. Have fun and good luck!

- Something that says "Made in Canada" on it
- A brown paper lunch bag
- A plastic plant
- A paper clip
- One Lego piece
- A business card
- A paper airplane
- A four leaf clover
- Any coin from 1980
- A coffee can
- A flag
- A tube of toothpaste
- Two children's books



Celebrate Literacy in the NWT

- A copy of the most recent local newspaper
- A map of something
- A ball
- Three different coloured leaves
- The tab from a pop can
- The phone number of the school
- A flyer advertising a community event.
- Something smooth
- An *NWT Literacy Council* pencil or eraser
- A black shoelace

Cardboard Obstacle Course

How fast can you get from the start to the finish? Create your very own obstacle course and race your friends and family. If you have lots of cardboard boxes you can use our outline below to design your own obstacle course.

Wiggle Through

Wiggle through a long box

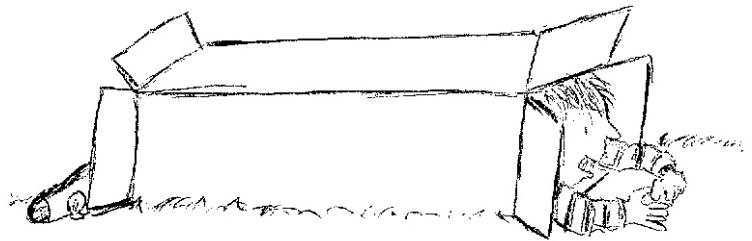

Jumping Boxes

Use twist ties to join three boxes together. Poke some holes in the boxes to fasten together with the twist ties. Jump from box to box.

Spell Detector

Get a parent to write up a paragraph from your favourite story that has spelling mistakes in it. Find five of them before moving on.

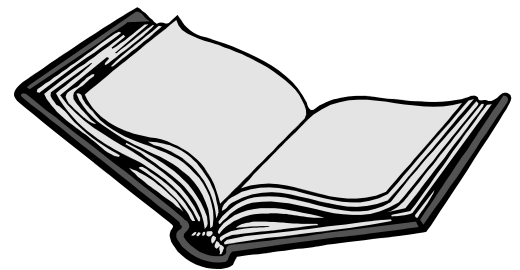

Don't spill

Fill a small open box of popcorn and place it on your head. Now try walking without spilling it.

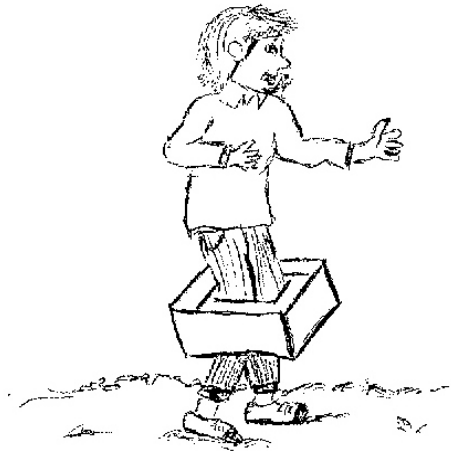

Walk-a-box

Take a medium sized box and cut a hole in the bottom. Put the box around your knees and try to walk without using your hands.

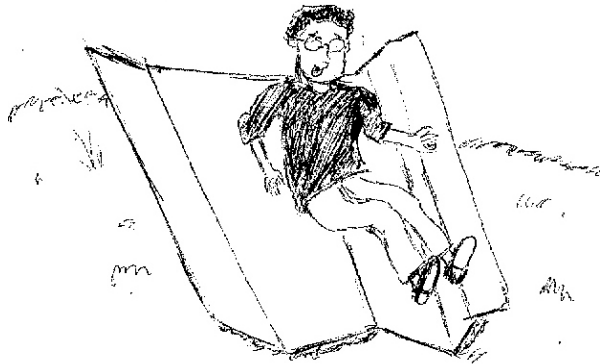

The Slide

If there is a hill around where you are building your obstacle course open up a large box and make a slide.



Sing-a-long

Sing a song and complete the actions before moving on. Examples of songs can be found in this How to Kit.

The Maze

Use boxes, blankets, chairs and anything else you can think of to make a crawl through maze.

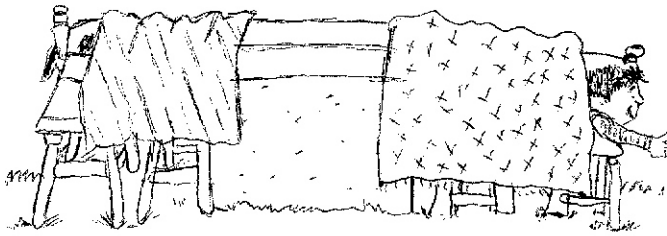

Hopping Box

Put your feet inside a small box and try to hop to your goal. This is similar to a sac race.



The Finish

Create a finish line with some string and banners.



At the Park



Baby/Toddler

All Kinds of Leaves: Autumn is a colour and beautiful time of year. Take your toddler out and show them these colours. Let them collect the leaves on the ground while introducing words for colour like *brown, orange, red* and *yellow*. Take the leaves home and do an art craft with them.

Preschooler/Kindergartner

Swing High, Swing Low: Take your child to a playground and show them all the equipment. While they are playing introduce new words to them for example, when your child is on the swing, you can say *"High, high, fly to the sky!"* each time you push him. As he comes down, you can say *"Down, down, swing to the ground!"* When your child is finished you should talk about his experience using interesting words. *"You were flying like a bird! How did it feel to soar?"*

First-Grader

Who Lives in a Tree?: The park is always full of life and nature. This makes it a great spot to help your children learn about how nature works with animals. Look around the park and ask your child questions, for example, *"Why do you think squirrels like trees?"* Tell your child that it would be fun to learn more about nature. *"We can look for a book about trees at the library or the bookstore."*



Charades

1. You need many short sentences or phrases written on strips of paper.
For example:
 - He goes bowling every week.
 - She often orders pizza for supper.
 - My father went to hunt ducks last weekend.
2. Put the strips of paper in a box or bag.
3. Divide participants into groups of 4 or 5.
4. One participant from one team draws a sentence or phrase out of the bag. They then act out the charade (the sentence or phrase), while the rest of the team tries to guess what it is.
5. The team gets one point if they guess the complete sentence within the time limit.
6. Other teams must watch quietly until it is their team's turn.

Log Pass

Age Level: 7+

Materials: Big log

1. Each player gets a different word.
2. Players must line up on a log in alphabetical order.
3. Now the player closest to A must switch places with the last player (from other end) without falling off the log.
4. Then the next player switches places with the next-to-the-last player and so-on till all have switched.

Variations:

Try getting the kids to create a sentence with their mixed up words.

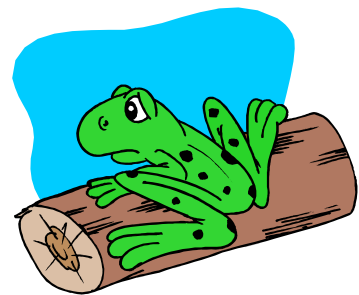

Still Photograph

Age Level: 8+



1. One player takes a few members of the group and tells them their favourite story/fairy tale.
2. The player then places them in a frozen picture retelling the story.
3. The rest of the group has to guess the story.
4. Whoever guesses correctly gets to pick the next story.

Find Your Animal Mate

Age Level: 3+

1. Animal names are written or drawn on a piece of paper. Each animal is named twice.
2. The children are given a slip so they know only their animal.
3. Then they act out the animal while trying to find their partner.
4. When two find each other they show each other their slips to see if they are right.

Variations:

Try it without sounds.

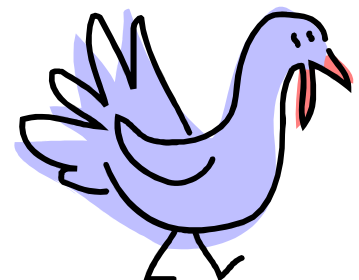



Celebrate Literacy in the NWT

Geocaching

1. Create caches of books or stories and store them in waterproof containers. Tupperware works great for this.
2. Hide these caches around your community. Make sure you use your GPS while hiding them so you can tell everyone where it is.
3. Create a list of your caches and make it accessible to people in your community. You can post it online or print them off and post them around town.
4. Children will have to read the coordinates from the GPS to find the cache.
5. When it has been located they may take one article from the cache as long as they replace it with something they have brought. Books or stories they have written work great.
6. Leave the cache for someone else to find.

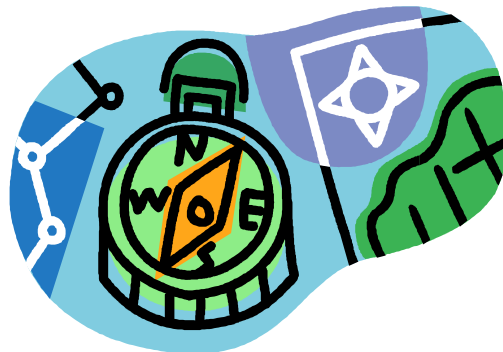

Make Your Own Castle Theatre

You will be in charge of what plays are put on when you own your very own theatre. Just follow the steps below.

You will need:

- Large cardboard box
- Scissors
- Pencil
- Tape
- Paints and paintbrushes
- Twist Ties
- String

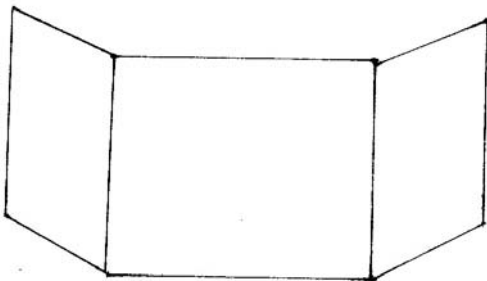

Step 1

Grab a large cardboard box and cut out the top and bottom. Once this is done cut out one of the long sides of the box.

Step 2

Decide how many towers you would like on your castle. Roll paper into tube shapes and tape them together to create your towers. Next measure the height of the castle on the tube. Using scissors cut up to this mark. Make the same cut on the opposite side of the same tube.

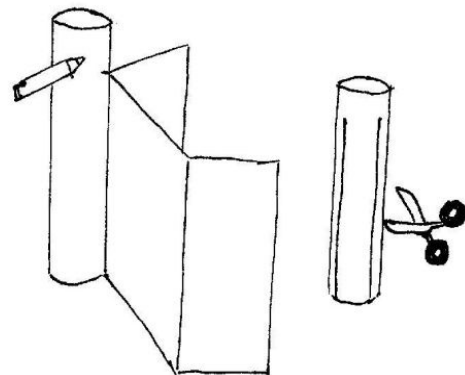

Repeat with all the tubes.

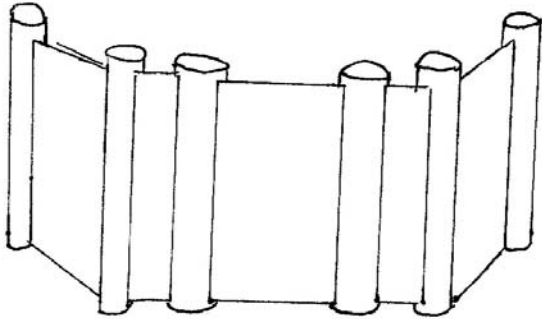

Step 3

Slide the tubes you just cut over the edge of the cardboard box. Place them at the corners and the ends. If you want to put towers in the middle of the box be sure to leave enough room for your drawbridge.

Step 4

Tape the tubes to your castle.

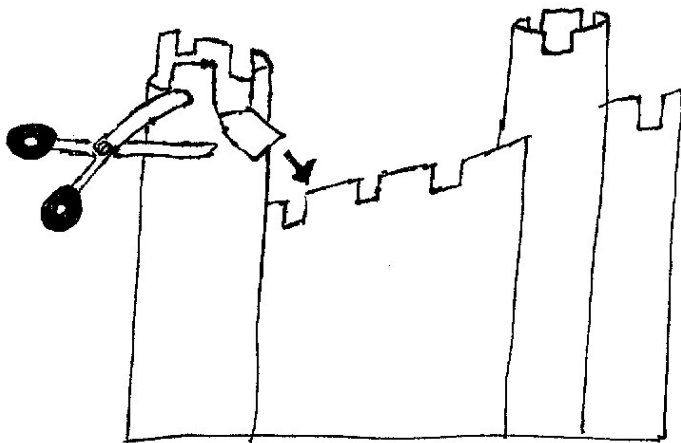
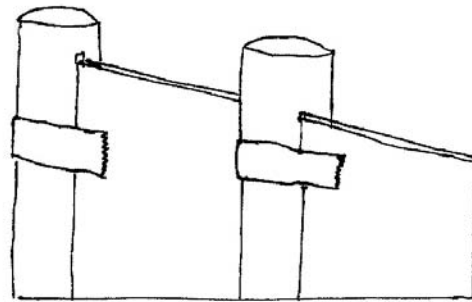

Step 5

If you would like turrets on your castle you just need to cut out notches around the towers and walls. You can do this by cutting two lines down and fold the cut section. Then cut this section out along the fold.

Step 6

Draw out your castle door with a pencil and cut it out. Save this cut out as it will be your drawbridge.

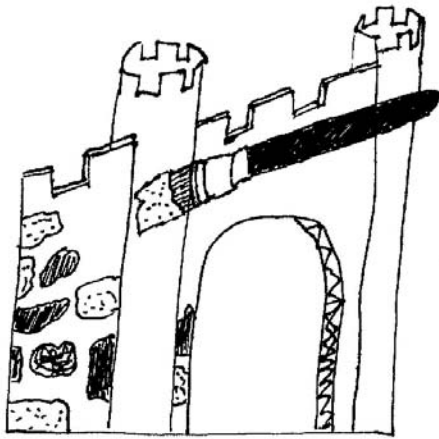
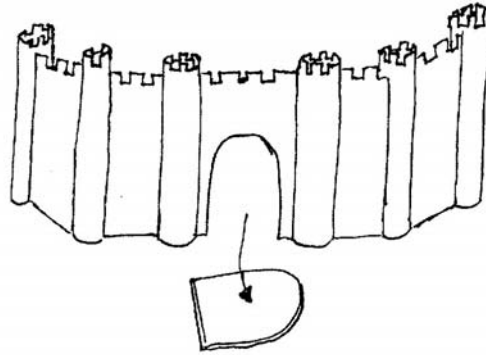

Step 7

Paint your castle however you like. Paint the drawbridge as well and let both dry.

Step 8

In order to make the drawbridge you will punch small holes in the bottom of the piece we cut out earlier. Punch two more holes in the walls beside the door hole. Use twist ties to attach the door to the castle. Do this by sliding them into both holes and twisting them at the back of the walls.

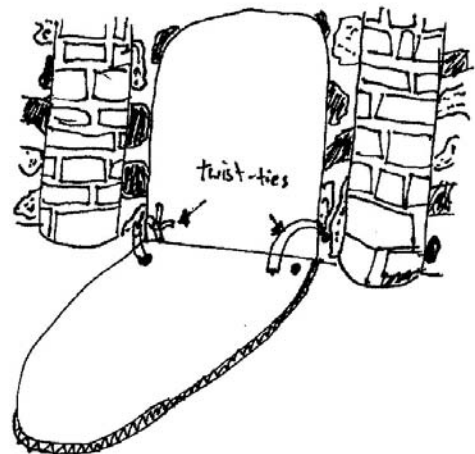

Step 9

To attach string to the drawbridge, make two small holes on the top sides of the drawbridge and two holes beside the top of the doorway. Put string through the holes and knot them. Make sure these knots are large so you can pull on the string to open and close the drawbridge.

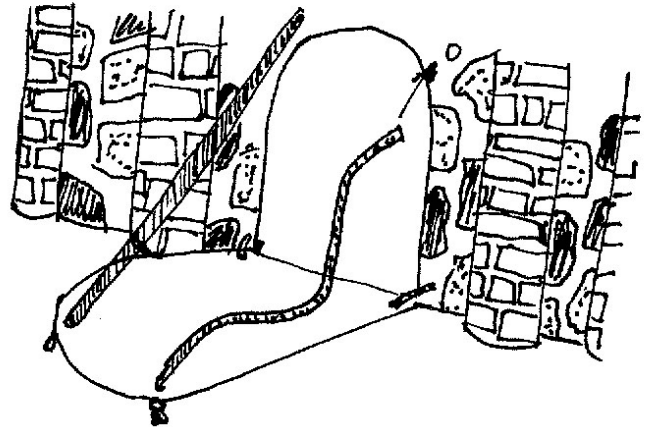

Puppets

Now that your theatre is complete you will need puppets to act out all your plays. If you do not already own some you can buy your own or refer to the *NWT Literacy Council's* *How to Kits: How to Kit Puppets* and *How to Kit Puppet-Making* and make your own.

Songs

Songs are a great way to teach your child new and interesting words. By adding actions to your children's favourite songs you can get them excited about being active!



Elephant Song

(actions in brackets)

What is that noise *(cup hand to ear)*

Up in the attic *(point over your head)*

It is an elephant *(make a trunk with your arm)*

Cycling round and round. *(cycling motion with legs)*

It is an elephant *(make a trunk with your arm)*

All chic and elegant *(fashion model pose)*

With one tail here *(make trunk with your arm)*

And one behind. *(point to where your tail would be if you had one!)*

Repeat the song a number of times, each time, you stop singing one line of the song, but continue to do the action for that line. By the end of the song all you're doing is actions, no singing.

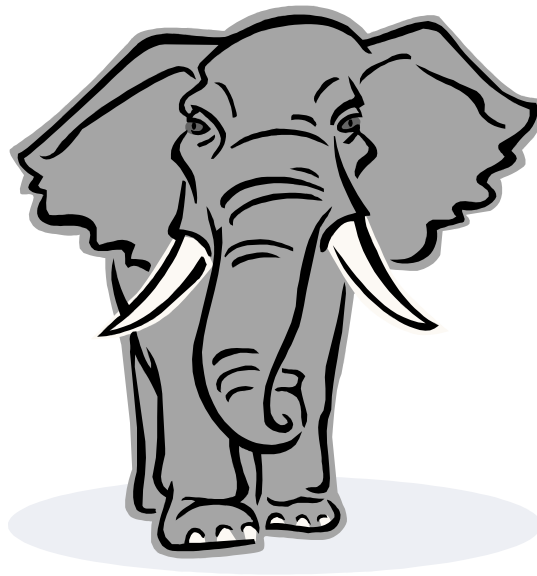

Pirate Ship

(actions in brackets)

When I was one *(hold up one finger)* I sucked my thumb *(suck your thumb)*

The day I went to sea, *(make waves with a hand)*

I climbed aboard a pirate ship *(climb an invisible ladder)*

And the Captain *(salute)* said to me,

"We're going north, *(stomp foot in front of you)*

South, *(stomp foot behind you)*

East, *(stomp foot to the left)*

West, *(stomp foot to the right)*

And up the Irish Sea, *(two hands beside each other, palms facing out, make an "up" motion towards your head)*

A bottle of rum *(drink from a bottle)* to fill my tum *(rub your belly)*

And that's the life for me!"

When I was two *(hold up two fingers)* I tied my shoe *(tie your shoe)*

The day I went to sea, *(make waves with a hand)*

I climbed aboard a pirate ship *(climb an invisible ladder)*

And the Captain *(salute)* said to me,

"We're going north, *(stomp foot in front of you)*

South, *(stomp foot behind you)*

East, *(stomp foot to the left)*

West, *(stomp foot to the right)*

And up the Irish Sea, *(two hands beside each other, palms facing out, make an "up" motion towards your head)*

A bottle of juice *(drink from a bottle)* to turn me loose *(and wiggle all around)*

And that's the life for me!"



Other Verses for Pirate Ship:

Three: scraped my knee (*brush your knee*)

Four: shut the door (*shut an imaginary door*)

Five: did the jive (*do a little dance*)

Six: picked up sticks (*pick up sticks*)

Seven: went to heaven (*point upward, act 'angelic'*)

Eight: closed the gate (*close an imaginary gate*)

Nine: stood in line (*look impatient*)

Ten: did it again (*look exasperated*)

Purple Stew

(actions in brackets)

Making a purple stew,

Whip, whip, whip, whip (*pretend to stir a huge bowl, circular motion with arms*)

Making a purple stooie-doobie-oobie-doobie

Purple potatoes, and purple tomatoes and (*pretend to throw things in from over your shoulder*)

You in my purple stew. (*person in middle points to someone*)

Fancy meeting you in my purple stew. (*the two shake hands*)

(Everyone stands in a circle while one person stands in the middle. While you are singing the song perform the actions. When you say "You in my purple stew" the person in the middle points to someone and that person joins the middle. On "Fancy meeting you..." the person who was just pulled into the circle shakes hands with the person who brought her there.)

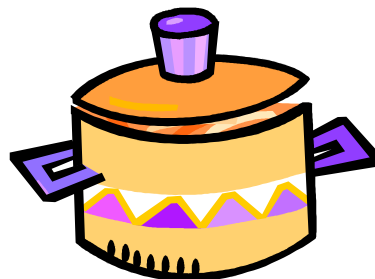



Slap! Slap! Slap! Mosquitoes are Biting

(actions in brackets)

Slap! Slap! Slap! Mosquitoes are biting (*slap your body for each "slap"*)
Hey there fellows, I've got one (*hold up one finger*)
And between my fingernails I will pinch his little tail (*make squishing action with fingertips*)
'Till he promises not to bite me on my thumb! (*point to thumb*)

Slap! Slap! Slap! Mosquitoes are biting (*slap your body for each "slap"*)
Hey there fellows, I've got two (*hold up two fingers*)
And between my fingernails I will pinch their little tails (*make squishing action with fingertips*)
'Till they promise not to bite me on my shoe! (*point to shoe*)

Slap! Slap! Slap! Mosquitoes are biting (*slap your body for each "slap"*)
Hey there fellows, I've got three (*hold up three fingers*)
And between my fingernails I will pinch their little tails (*make squishing action with fingertips*)
'Till they promise not to bite me on my knee! (*point to knee*)

Slap! Slap! Slap! Mosquitoes are biting (*slap your body for each "slap"*)
Hey there fellows, I've got four (*hold up four fingers*)
And between my fingernails I will pinch their little tails (*make squishing action with fingertips*)
'Till they promise not to bite me anymore!

The Grand Old Duke of York

(actions in brackets)

The Grand Old Duke of York

(march on the spot during this line)

He had ten thousand men

(march on the spot)

He marched them up to the top of the hill

(keep marching and stretch up really tall)

And he marched them down again.

(march down, until you are squatting, or duck walking)

And when they were up they were up

(gradually get taller again, until tiptoed)

And when they were down they were down

(go down till you are duck walking again)

And when they were only half way up,

(go half way up, and march crouched over)

They were neither up nor down.

(when you say up, jump up and when you say down, squat down)

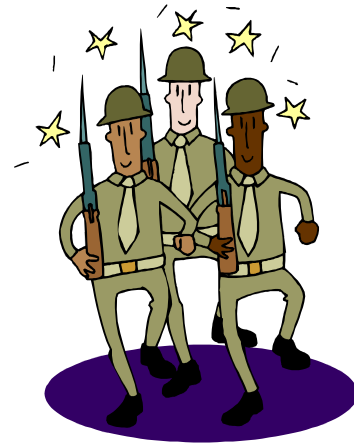

The Hippo Song

(actions in brackets)

What can make a hippopotamus smile? *(shrug shoulders, trace a smile)*
Boom, boom, boom, *(bump bums with your neighbours)*
What can make her walk for more than a mile? *(shrug shoulders, hike action)*
Not parties with their paper hats *(arms over head as a party hat)*
Nor candies nor cakes that make her fat *(stuff mouth with food, hold belly)*
That's not what hippos do! *(shake finger "no")*
What do they do? **THEY---** *(hands on hips, on "THEY", cup hands to shout)*
Ooze in the goo without any shoes *(play with invisible mud in your hands)*
And they wade in the water 'till their lips turn blue *(dribble fingers on lips)*
That's what makes a hippopotamus smile! *(trace a smile)*
Boom, boom, boom *(bump bums with your neighbours)*

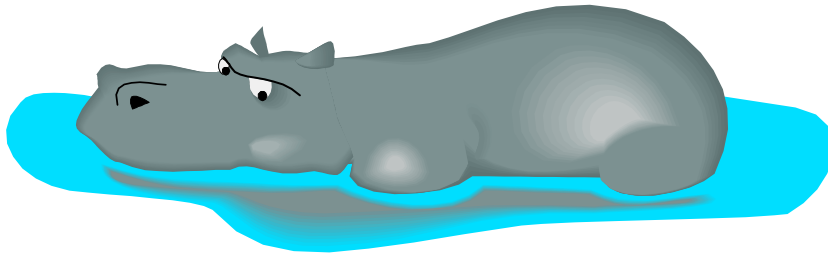

What can make a hippopotamus smile? *(shrug shoulders, trace a smile)*
Boom, boom, boom, *(bump bums with your neighbours)*
What can make her walk for more than a mile? *(shrug shoulders, hike action)*
Not swooshing down a slippery slide *(slide action with hands)*
Or going for a bicycle ride *(bike on the spot)*
That's not what hippos do! *(shake finger "no")*
What do they do? **THEY---** *(hands on hips, on "THEY", cup hands to shout)*
Ooze in the goo without any shoes *(play with invisible mud in your hands)*
And they wade in the water 'till their lips turn blue *(dribble fingers on lips)*
That's what makes a hippopotamus smile! *(trace a smile)*

Boom, boom, boom (*bump bums with your neighbours*)

Stories

Children of all ages enjoy stories whether they are read to them or they pick up the book themselves. The exercise gained from reading doesn't have to be limited to turning the page. In this section we show you how children can have fun reading while still being active.





Brown Bear, Brown Bear

This is an activity you can do with your kids while reading Bill Martin Jr.'s *Brown Bear, Brown Bear, What Do You See?*

You will need:

- Strips of paper
- Tape
- Colour markers
- Craft supplies (feathers, fur, etc)

1. Get a copy of *Brown Bear, Brown Bear, What Do You See?*
2. Create sentence strip headbands for all the different animals in the story.
 - a. The children will take a strip of paper and tape it together at the ends to form a ring or headband.
 - b. The animal they are to create can be written on it. You may wish to write out the colour of the animal (Brown Bear) or you may write the animal name in the colour they are supposed to be (Bear).
 - c. The children will then colour, glue ears or feathers or whatever they wish to create their very own animal.
3. As you read the story to the kids they will act like their animal as they are called out. You might need to help them with how to act out their animal.
4. Let them have fun! You certainly will.

We're Going on a Bear Hunt

Children listen to the story *We're Going on a Bear Hunt*, as the adult reads the story aloud. As each obstacle pops up in the story the adult will model the action and the kids will mimic. Although you can make up whatever actions you wish we have examples below.



Long wavy grass – Sweeping arm motions making swishing sounds.

A deep cold river – Pretend to swim, stroking with your arms.

Thick oozy mud – Slowly pull feet (or arms) up as if stuck in mud.

A big dark forest – Pretend to climb a tree.

A swirling whirling snowstorm – Pretend to shiver.

A narrow gloomy cave – Pretend to feel carefully in front of your face with your hands.

When you find the bear – Pretend you are terrified and feeling the fur on the bear's face.

While running home – Do all of the actions again quickly and dramatically.

The Moccasin Goalie

Read the story *The Moccasin Goalie* by William Roy Brownridge to the children. Hockey is a fun way to get exercise. Encourage your children to play hockey outside after the story. Some tips to help you out:

- Ice ponds are a great place to play hockey with a group of friends. Always have an adult check to see if the ice is safe before going out to clear the snow.
- Quiet streets are also a great place to play hockey, especially if there are no ponds close to your house or it is summer. This is perfect if you have limited equipment as well for skates are not needed. A softer ball can be used so goalie pads are not essential.
- Mini sticks can also be used to play indoor hockey.

